

# The Continuous Vertical Datum for Canadian Waters Project: Overview & Status Report

C. Robin<sup>\*1, 2</sup>, S. Nudds<sup>1</sup>, P. MacAulay<sup>1</sup>, A. Godin<sup>1</sup>, B. de Lange Boom<sup>1</sup>, J. Bartlett<sup>1</sup>, L. Maltais<sup>1</sup>, T. Herron<sup>1</sup>, K. Fadaie<sup>1</sup>, M. Craymer<sup>2</sup>, M. Véronneau<sup>2</sup>, D. Hains<sup>1</sup>; \* Presenter

<sup>1</sup>Canadian Hydrographic Service, Fisheries & Oceans Canada

<sup>2</sup>Canadian Geodetic Survey, Natural Resources Canada

## Abstract

In 2010, the Canadian Hydrographic Service (CHS) in collaboration with Canadian Geodetic Survey (CGS) began development of the CVDCW project. The goal is to develop a surface connecting chart datum (CD) to the national geodetic reference frame which captures the relevant spatial variability as modeled by integrating ocean models, water levels, GPS observations, sea level trends, satellite altimetry, and a geoid model. The CVDCW's CD surface will define a new hydrographic datum for Canada; other CVDCW surfaces (e.g. low water, high water) will provide fundamental pieces of information for coastal studies, climate change adaptation, and the definition of the Canadian shoreline and offshore boundaries.

We have developed a national approach which is flexible enough to adapt to regional differences and permits the integration of new gauge and model data and improved methods as they become available. Given that Canada has more than 200,000 km of shoreline and the large-scale approach of the CVDCW, many aspects of our method are innovative and have not, to our knowledge, been used by other hydrographic organizations in the world.

A prototype of the CVDCW is now available for all Canadian Tidal Waters. Realizations of the CVDCW are expected to evolve quickly in the next few years, as the prototypes are improved and validated.

## Introduction

In the early 1990's, the CHS recognized the need to link chart datum to a national geodetic reference frame in order to take advantage of Global Navigation Satellite Systems (GNSS) technologies for hydrographic sounding and data reduction. Since then they have carried out a national campaign of GNSS surveys on tide gauge benchmarks as well as establishing new or revised water level observations. In the early 2000's a sufficient number of chart datum (CD) to ellipsoid separations had been established to create simple models linking CD to the ellipsoid (separation models, or SEPs), which cover areas ranging in size from that of a port to that of the St. Lawrence River and Estuary. These were created by applying geospatial interpolation techniques to GNSS-observed CD to ellipsoid offsets, and covered a small fraction of the navigable tidal waters for which the CHS is responsible. As expected, simple SEPs of this type are often inadequate within 10 km or less of GNSS-observed tide stations, because they do not include any data between tide stations and offshore.

In 2010, the CHS initiated the Continuous Vertical Datum for Canadian Waters (CVDCW) project to produce physically realistic SEPs which capture spatial variability at all relevant scales by

incorporating spatial data from multiple sources. The project has been developed by a core team of tidal officers, modellers and geodesists from the CHS and the CGS, with support from DFO's Ocean Sciences group and oceanographers from academia and private industry.

In addition to their use in hydrography, SEPs will help join ocean- and land-based observations by linking bathymetry with topography through a common reference frame. This will permit the definition of coastlines and intertidal zones on a national scale, help define maritime boundaries, marine cadastres and claims to sovereignty, serve as a baseline for sea level rise and related climate change adaptation strategies, and be key for coastal infrastructure maintenance and development.

Our methods differ in a number of respects from those of similar projects led by other hydrographic organizations, such as VDatum in the United States (Parker et al. 2003) or VORF in the United Kingdom (Iliffe et al., 2007). Due to the vast size of our coastline, the variable density of our tide station network, and the national approach of the CVDCW, many aspects of our methods are unique. The CVDCW will be available as 4 or 5 large regional grids, but adopts a method which is flexible enough to accommodate variations in geographical and navigational requirements, as well as the integration of new information as it becomes available.

Currently a prototype of the CVDCW exists for all of Canada, for CD and 7 other water datums. These will be tested and validated in the 2014 field season, in parallel with an ongoing data acquisition program to densify our shore control (GNSS and water level observations). In this paper we present an overview of the methods we have developed and the treatment of our input data, using a set of our prototypes as examples.

## Method

To capture the spatial variability of water levels between tide gauges and offshore, we validate and integrate data from tide stations, ocean models, geoid models, a crustal velocity model and sea level rise estimates, and satellite altimetry. Our final product is a set of SEPs mapping water level datums to the GRS80 ellipsoid in the NAD83(CSRS) reference frame, calculated at each node of a finite element grid. CVDCW calculations are primarily done in Matlab using a SEP Toolbox we have developed.

Figure 1 outlines the CVDCW process. The core of the procedure is a vertical stack of discrete layers, each of which integrates pieces of the input data. Each layer contributes a vertical portion of the separation between a water level datum and NAD83(CSRS). In each layer we manipulate and integrate input data using a variety of numerical methods in the manner described below.

After an initial assessment, quality control of the input data progresses iteratively as each data point is inspected visually and by statistical means through the modeling process. This has provided the CHS with the opportunity to update, improve and fill gaps in their tide stations network. CVDCW data integration and interpolation methods have evolved in parallel.

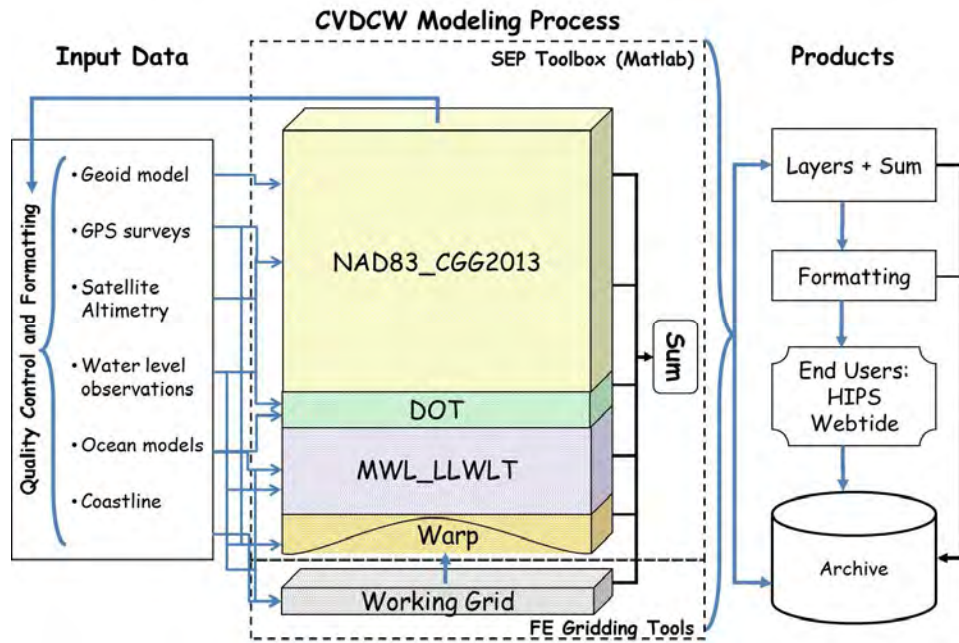

Figure 1. CVDCW modeling process.

## 1. Tide station data

### i. Tidal Constituents

In Figure 2 we plot existing CHS stations in tidal waters. As of spring 2014, water levels have been observed at 1266 tidal stations, 423 of which have been tied into a geodetic reference frame, typically via one or more 24-hour GNSS occupation on station benchmarks. At each station CD has been defined relative to one or more station benchmarks by leveling. Water levels are observed for periods ranging from 10 days to 100+ years; the majority were observed after 1960. From these observations between 10 and 69 tidal constituents are extracted for each station. In the Quebec and Pacific regions, long-term constituents have been interpolated from stations with many years of observations to shorter-term stations and integrated into their constituent sets. Using these constituents sets we calculate 19 year water level predictions for an epoch centering on 2010, and target water levels are extracted from the predictions (see Appendix 1). Before inclusion in the CVDCW, each station is assigned a quality indicator based on these and other variables by each region's Tides and Water Levels group<sup>1</sup>.

In Canada, CD targets Lower Low Water Large Tide (LLWLT), defined as the average of the yearly predicted water level minimums from a 19-year astronomical cycle (ie the average of 19 predicted values). Thus the first SEP we calculated,  $SEP_{LLWLT}$ , which we present in this paper, is for LLWLT. In most cases, however, currently adopted CD is offset from LLWLT, especially where CD was established some time ago and/or in areas of large relative sea level changes. Thus we create a distinct SEP for CD, by forcing or warping the LLWLT model to pass through currently adopted CD at and in the vicinity of tide stations (see Layer *iv*), so that  $SEP_{CD}$  is

<sup>1</sup> The CHS operates 4 regional offices (Pacific, Central & Arctic, Atlantic and Quebec) with a head office in the National Capital Region.

coincident with what has been used on existing hydrographic products. We have also calculated SEPs for the six other water level datums defined in Appendix 1.

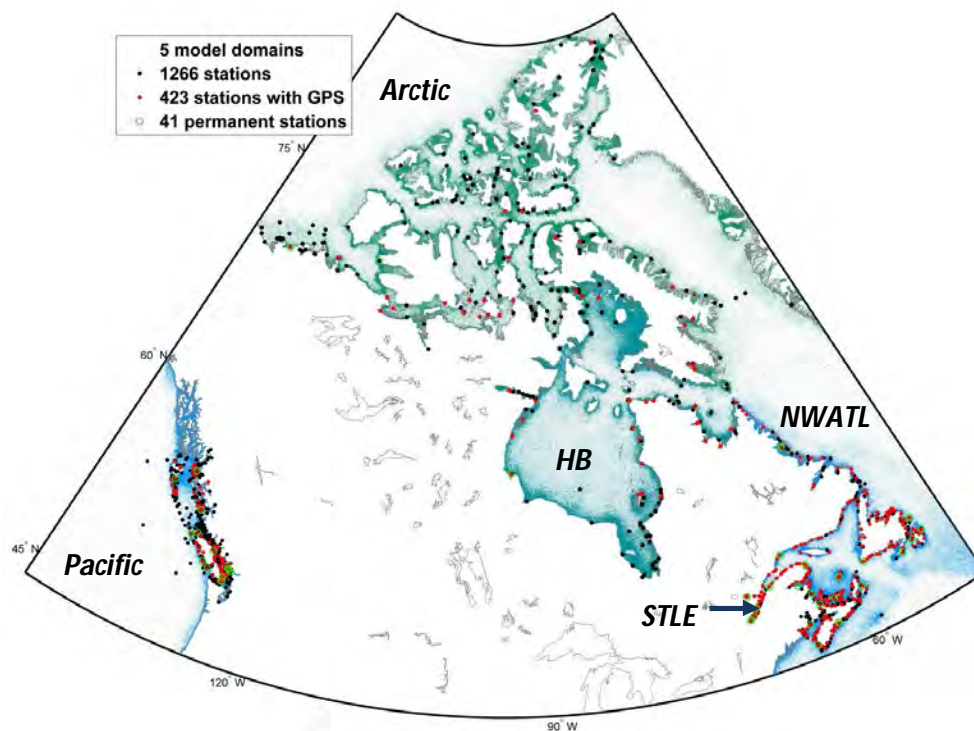

**Figure 2. Map showing the locations of CHS tide stations and CVDCW model domains. The model domains include the Pacific, the Arctic, Hudson’s Bay (HB, which includes Foxe Basin and the Hudson Strait), the North West Atlantic (NWATL, which includes the Gulf of St. Lawrence), and the St. Lawrence Estuary (STLE, which begins roughly at the tip of the arrow and continues to Quebec City). Of the 41 permanent tide gauges currently operating, 4 are in the Arctic region and are co-located with permanent GNSS stations, and one is in Hudson Bay.**

## ii. Epoch Updates

Before integrating tide station observations into our SEPs, we bring of all our data to the 2010 epoch. The offset between CD and MWL (CD\_MWL) changes with time due to crustal uplift or subsidence combined with changes in sea level. This will have a negligible effect if any on the station’s tidal constituents and estimates of tidal amplitude, but will affect the relationship between MWL and the ellipsoid<sup>2</sup>. In the absence of local instabilities affecting tide station infrastructure, CD will remain fixed in time relative to its benchmark; both CD and the benchmark will move relative to NAD83 at the rate of crustal uplift or subsidence; and MWL will move relative to NAD83 at the rate of absolute sea level rise, and relative to CD at the combined rate of absolute sea level rise and crustal motion. Hence bringing tide stations which may be up to 100 years old

<sup>2</sup> MWL is estimated relative to CD based on water level observations made at the time CD was established; this is also the time CD is tied to one or more station benchmarks by geodetic leveling. Thus CD is fixed relative to a land-based marker. MWL, on the other hand, is not fixed to anything, and changes relative to land, and therefore relative to CD. The ellipsoidal height of CD is measured by GPS survey on the station benchmark. Thus GPS will determine the ellipsoidal height of CD via the benchmark at the time of the GPS survey.

and GNSS observations which may be up to 20 years old to a common epoch is important; epoch updates can be up to  $\pm 1$  meter in height.

Crustal uplift is the result of tectonic forces such as mountain-building in the Pacific region or Glacial Isostatic Adjustment (GIA) of the crust following the retreat of ice sheets over central Canada. The resulting crustal velocities have been observed at a network of permanently operating GNSS sites implemented by NRCan, and a crustal model developed from these is available at the NRCan/CGS web portal (Canadian Geodetic Survey, 2014). Absolute SLR is due to the melting of land-based ice along with a general warming of the climate, and has been estimated at  $\sim 2$  mm/year globally, with regional variations (Rhein et al., 2013). Where absolute SLR is large and the crust is subsiding or rising relatively slowly, tide stations experience relative sea level rise; where absolute SLR is slower than crustal uplift, tide stations will experience relative sea level fall.

At stations with more than 20 or 30 years of water level observations, we have measured the trend in relative SLR. For the majority of tide stations, however, this is not possible. Instead, we use the long-term stations in combination with NRCan's crustal velocity model to calculate regional estimates of absolute SLR. We then use these estimates in combination with NRCan's crustal velocity model to estimate relative SLR at each station as follows:

$$SL_{\text{corr}} = (2010 - Z0\text{epoch}) \times SLR_{\text{rel}}$$

where

$$SLR_{\text{rel}} = v_{\text{crust}} + SLR_{\text{abs}}$$

Here  $SL_{\text{corr}}$  is the sea level correction in meters,  $Z0\text{epoch}$  is the year that the CD\_MWL was last measured,  $SLR_{\text{rel}}$  is relative sea level rise in meters per year,  $v_{\text{crust}}$  is crustal velocity in meters per year, and  $SLR_{\text{abs}}$  is absolute sea level rise in meters per year. We apply  $SL_{\text{corr}}$  to all water level datums referenced to CD (LLWLT, MWL, etc).

It should be noted that this procedure works well in the Atlantic and Hudson Bay regions where crustal velocities are well constrained and vary smoothly. In the Arctic the crustal velocity model is poorly constrained at this time; along the Pacific coast the tectonics of the Cascadia subduction zone are highly complex, and crustal velocities vary considerably across distances as short as 10 km. We are examining other methods of calculating sea level rise corrections in those regions. New methodologies are also being investigated by NRCan to improve their crustal velocity model (M. Craymer, personal communication).

Most of our GNSS data has been collected in the last 10 years, with a small number having been last surveyed up to 20 years ago. Most GNSS data has been brought to the epoch 2010 with the crustal velocity model using NRCan's datum and epoch transformation software TRX (Canadian Geodetic Survey, 2014); in some cases, the original GNSS observation files have been re-processed entirely, also bringing the observations to the 2010 epoch.



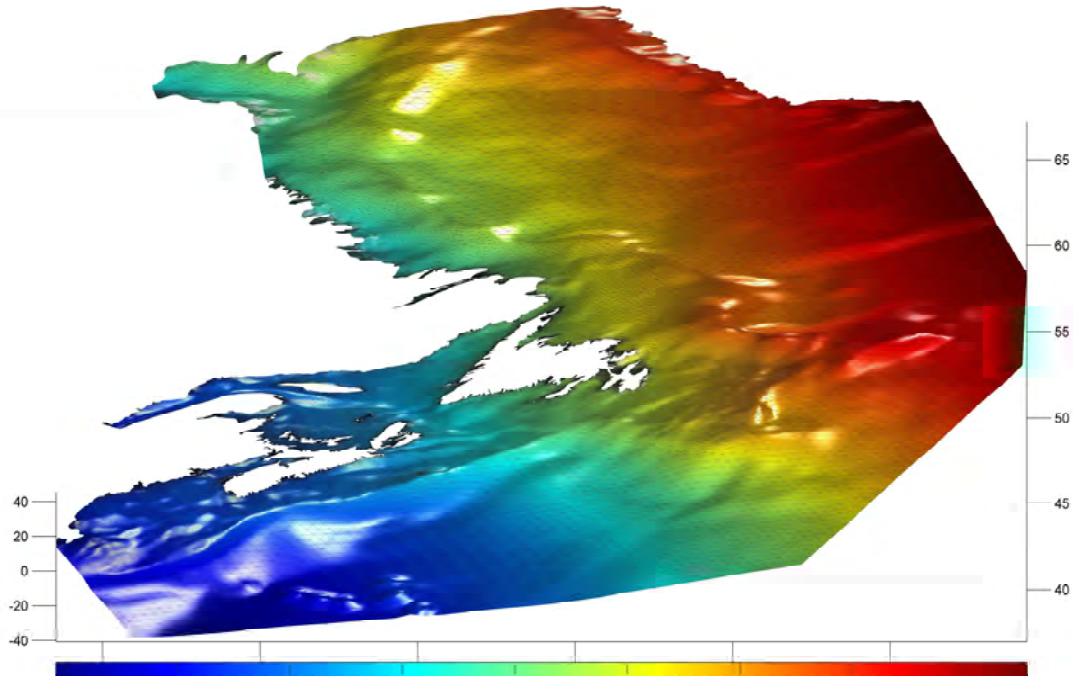

**Figure 3. Geoid height in meters and triangulation of the working grid for the NWATL model. The area spanned by the grid is based on the coverage of large-scale ocean models; however, the working grid boundaries extend up to or over the shoreline, include nodes where there are tide stations, and the interior grid has been re-created using the finite element gridding routine Resolute (Chaffey & Greenberg, 2003). The distribution of nodes is defined by the depth and gradient of the bathymetry; the direct and indirect gravitational effects of the bathymetry are also evident in the gravimetric geoid.**

## **2. Working Grid**

Underpinning all of our calculations is a carefully designed finite element (FEM) grid, the working grid, onto which we integrate observed and modeled data. Each layer is calculated on this grid, and exploits its connectivity to guide interpolations in a physically realistic way (for example, avoiding interpolations over land and keeping tidally restricted areas numerically isolated). Most of our interpolations are performed on the working grid using an implicit 2D FEM Lagrangian algorithm; in other words, we model the transfer of tidal information as if it were heat. We have found that a grid-based method in combination the Lagrangian interpolator is efficient and more physically realistic at all scales than other geospatial interpolation methods we have tested. We apply the same gridding and data integration methods for all of our model domains regardless of size.

Currently, the CVDCW is divided into 5 areas, namely the Pacific Coast, the Arctic, Hudson's Bay, the Northwest Atlantic, and the St. Lawrence Estuary, based on the coverage of 5 large-scale ocean model grids (see Figure 2). However, ocean model grids reproduce the coastline very approximately, and do not cover all water. Because our calculations are computationally cheap, we are able to resolve the coastline in some detail even for grids covering large areas. Our working grids start with boundaries which extend up to and/or over a selected coastline<sup>3</sup>, are assigned a

<sup>3</sup> Note that no official coastline representing the intersection of land with a tidal water level exists for Canada at this time. We have used a collection of coastlines which are pieced together from charts, aerial photography, and topographic maps by other groups. A priority outcome of the CVDCW will be the ability to create mean water level or

node at every tide station location, and finally are populated with internal nodes using a finite element gridding routine. The finite element gridding routine is performed outside of Matlab using Resolute (Chaffey & Greenberg, 2003); all other parts of the SEP Toolbox are scripted in Matlab.

### 3. Layers

#### i. Geoid Height ( $N$ )

The foundation of our SEPs is a geoid model (Figure 3). A geoid is a gravitational equipotential (or ‘level’) surface which best represents Mean Sea Level ( $MSL$ ). That is, a geoid maps where water would fall if it were all of the same density. Undulations in the geoid are caused by variations in gravitational attraction resulting primarily from density variations in the land mass. We use the Canadian Gravimetric Geoid model of 2013 (CGG2013), which also defines the Canadian Geodetic Vertical Datum since November of 2013, and is available from NRCan. CGG2013 integrates data from terrestrial gravity measurements (land, ship and airborne observations) as well as gravity measurements from dedicated satellite gravity missions. As such, it maps variations in  $MSL$  over all of Canada including offshore. It also provides our SEPs their link to the ellipsoid, as geoid heights are calculated relative to the ellipsoid, denoted by the variable  $N$ . Applying the geoid alone between tide stations and offshore would be a great improvement over existing SEP models, and the spatial variability in our SEPs is to first order the result of geoid undulations.

#### ii. Dynamic Ocean Topography ( $DOT$ )

The gravitational potential ( $w_0$ ) chosen for CGG2013 was selected to fit the average *local MSL* observed at a selection of tide gauges around North America. In reality, *local MSL* or Mean Water Level ( $MWL$ ) (that is,  $MSL$  as observed at any one point) does not fall on an equipotential surface<sup>4</sup>. Sea water varies in density due to differences in temperature, salinity, currents, and other variables, causing the bulk gravitational force on the water column to vary from place to place. Indeed, while CGG2013 is the best fit to  $MWL$  around North America, it is on average 17 cm below  $MWL$  along the Pacific Coast where the water is relatively warm and of low density, and on average 39 cm above  $MWL$  in the St. Lawrence Estuary where waters are relatively cold and dense. This variability can occur on a variety of scales, for instance ranging from 39 to 89 cm in the St. Lawrence Estuary due to the heavy influx of fresh water from upstream. Here we use the term dynamic ocean topography ( $DOT$ ) to refer to the difference between  $MWL$  and CGG2013, which may be observed or modeled.

In general  $DOT$  contributes on the order of  $\pm 10$  cm to the vertical separation between water level datums and the ellipsoid (Figure 4). This is comparable to the noise in our station data. Using only the best quality stations would eliminate all but a small set of stations, leaving most of our coast

---

high/low water level coastlines on a national scale. Following that, both the CVDCW working grids and national coastlines will improve over time in an iterative manner.

<sup>4</sup> We use  $MWL$  or *local MSL* to denote the mean value of a water level time series. In contrast,  $MSL$  is used to denote an equipotential surface which fits observed  $MWL$  in a least squared sense over some domain. Finally, we denote as a Mean Sea Surface model, or  $MSS$ , a surface which maps  $MWL$  from one or more sources in some continuous fashion relative to a geodetic reference frame, in our case the GRS80 ellipsoid in the NAD83(CSRS) reference frame.

with no observations; in other words, our stations cannot resolve DOT sufficiently for our purposes even along the coast. Instead we use DOT estimates from ocean circulation models. Where more than one DOT model is at our disposal, we perform a comparison for each against tide gauge and satellite altimetry observations (see Figure 5 and explanation below) to select one (see Appendix 2 for list of DOT models used). DOT from ocean models are referenced to their individual model zero's, which are equipotential surfaces by definition (gravitational force at the initial water surface is zero), but do not correspond to any known geoid model. Thus we apply a single vertical offset to the entire model DOT which is equal to the mean difference between the DOT model and DOT observed at tide gauges. Once a DOT layer is summed with the geoid layer, we have a value for *MWL* relative to the ellipsoid at every node in the model domain, which is our Mean Sea Surface (*MSS*) model.

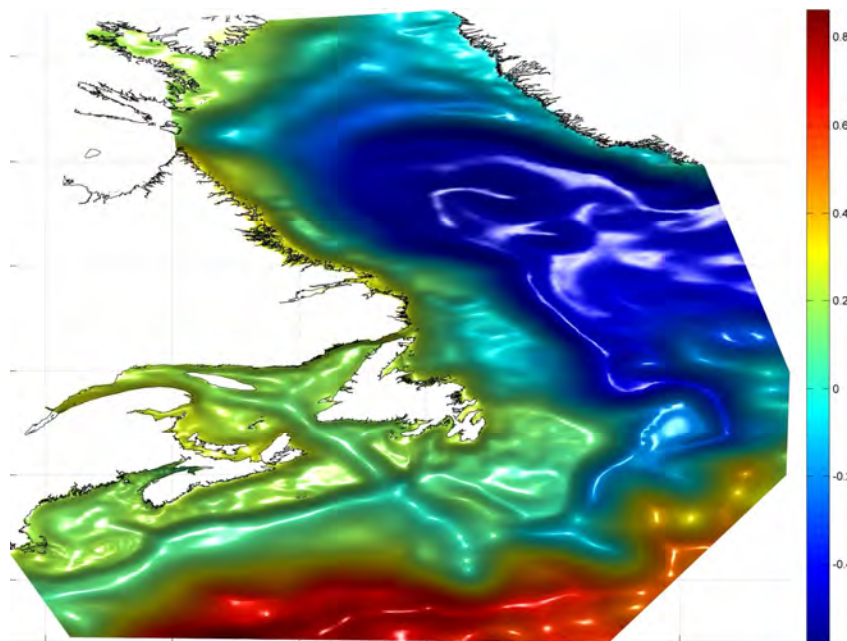
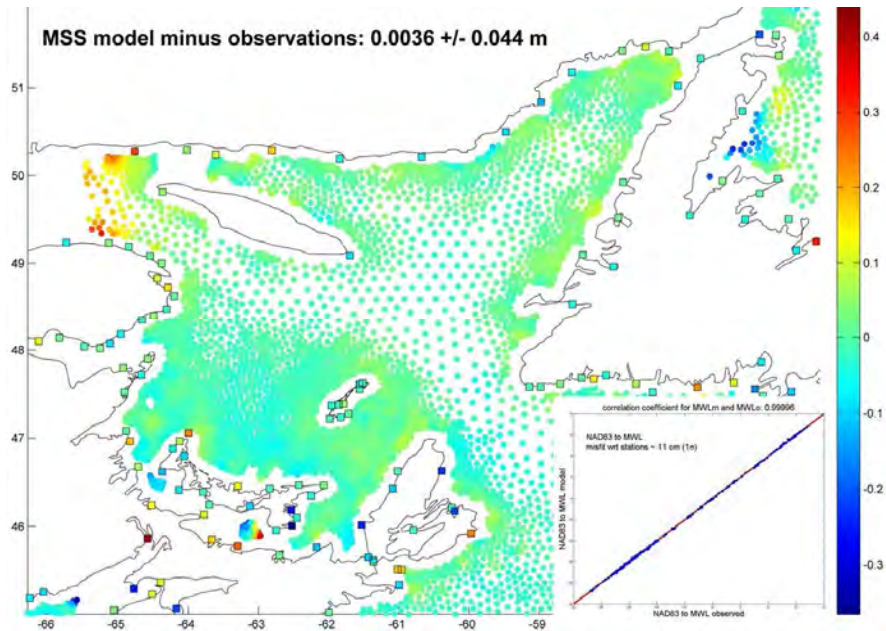

**Figure 4.** DOT from the ocean models of Wang & Greenan and Brickman & Drosdowski, which have been combined and interpolated to the NWATL working grid. Taking into account that the zero of this plot is arbitrary, note that the range in DOT heights spans a  $\pm 10$  cm range near the coast, which is of the same order as the noise in the station data.

Another approach is to measure *MSS* directly relative to the ellipsoid via satellite altimetry; however, satellite altimetry suffers from interference effects with land in coastal areas, and can only be used outside a 10-20 km buffer from the coast. This of course corresponds to the most important areas for navigation and most other applications of the CVDCW. In Figure 5 we show a comparison between observations and our *MSS* model, where satellite altimetry is included outside a 14 km buffer (Iliffe, 2007; MSS\_CNES\_CLS11). The 14 km buffer leaves large gaps in important areas, for instance over the entire St. Lawrence Estuary model and the Northumberland Strait; in the Pacific and the Arctic Archipelago, the gaps are more numerous and often larger. Therefore, instead of combining satellite altimetry data where it is available with geoid and/or tide gauge data close to shore, we take a more uniform approach and interpolate DOT models to each and all of our model domains. The DOT model will be modulated to some extent by station data



after all layers have been summed, especially important where our working grids extend beyond DOT model boundaries. Thus at this time we use satellite altimetry strictly for validating our *MSS* model offshore; near shore we validate *MSS* against tide gauge observations (Figure 5). When compared with the combined data sets, our *MSS* model ( $N + DOT$ ) is in agreement with observations to within 4 cm ( $1\sigma$ ). As expected, there is greater variability in the comparison with tide gauges (Figure 5 inset), since the quality of gauge datums varies between gauges, whereas satellite altimetry observations are distributed more densely in space and more evenly in time.



**Figure 5. Comparison of our *MSS* model with observations for the Gulf of St. Lawrence, using satellite altimetry offshore and tide gauges along the coast. Satellite altimetry observations are from the *MSS\_CNES\_CLS10* compilation (REF), from which we selected *MSS* values with a quoted error of  $\pm 5$  cm or less. Our *MSS* model is in agreement with all observations to within 4 cm ( $1\sigma$ ). The inset shows the correlation between the *MSS* model and MWL at tide gauges only.**

### iii. Tidal regime

The third layer joins MWL to the target water level datum, LLWLT in the case presented here; the MWL to LLWLT amplitude (MWL\_LLWLT) is approximately equal to half the tidal range, and is a function of the tidal regime<sup>5</sup>. Gauges capture variations in tidal regime at isolated points along the coast, while tidal regime can vary significantly and non-linearly between tide stations, in addition to offshore. Furthermore, the density of tide stations in Canada is highly variable, as is the length of observations. We nevertheless want to include as many tide station observations as possible, especially in areas of sparse shore control such as the Arctic and the Labrador coast, to inform our SEPs along the coast.

To fill in the gap between stations and offshore we integrate tidal water level data from hydrodynamic ocean circulation models, as we did in the DOT layer. The ocean models we selected cover large areas (Figure 2), and were chosen because of the large-scale approach of the

<sup>5</sup> Since tidal datums are defined relative to CD,  $MWL\_LLWLT = -(CD\_MWL) + CD\_LLWLT$ .

CVDCW. However, large-scale ocean models suffer from 2 limitations important for our project: first, they are typically optimized to reproduce currents, a few individual tidal constituents, or other oceanographic variables, and are relatively less adept at predicting the tidal extremes which define tidal datums; second, the boundaries of ocean models rarely reach the coast (or our tide stations), and certainly do not cover all tidal waters, including fjords, tidal rivers, and tidal lakes, as is required of the CVDCW, where the tidal regime can change significantly over short distances.

Our approach, then, is to modulate ocean models with tide station observations on our extended working grid. Integrating ocean models with trends in station observations permits us to model tidal dynamics in more detail than ocean models can provide alone, and overcomes some of the limitations of the ocean model's underlying physics. For this we depend on the careful structuring of the working grid to guide ocean model modulation appropriately.

The ocean models we use are forced by observed and/or modeled tides at their boundaries and typically include average seasonal effects such as freshwater influx, winds and ice (see Appendix 2 for references). Each model is run for a period ranging from 6 months to a year, preferably the latter, producing a water level time series spanning that duration at each node in the model grid. In the same manner as for tide stations, tidal constituents are calculated from water level time series, a 19-year prediction is calculated, and the target water level is extracted from the predictions at each node of the ocean model. We then interpolated and/or extrapolated to our working grid using the Lagrangian interpolation algorithm. We perform a series of tests on each model which evaluate its ability to reproduce the full tidal range, MWL\_LLWLT, and the tidal asymmetry (the difference in amplitude between MWL\_LLWLT and its high water inverse, MWL\_HHWLT) in a statistical sense. This allows us to select an ocean model when more than one is available, and gives us confidence in the model we have selected. An important feature of these models is that they were available or close to being available when we began work on the CVDCW; as other models become available to us, both small- and large-scale, we will incorporate them into future iterations of the CVDCW wherever possible.

All our selected ocean models differ from observations, and these differences exhibited regional trends considerably larger than the variance between stations. We use these trends to modulate the ocean models, in three steps. First, we take the ratio of observed to modeled MWL\_LLWLT; second, we interpolate the ratios from the station nodes to the working grid; and third, we smooth the interpolation. The result is a layer with a value on each node of the working grid that indicates if the ocean model's tidal amplitude should be increased or decreased, and by amount. The smoothing process reduces the influence of noise in our station data, so that we modulate the ocean tidal regime towards the observed one only when a group of stations exhibit similar mismatches with the ocean model. The amplitude ratio grid is then applied as a multiplicative factor to the ocean model at each node of the working grid. In areas where the ocean model was extrapolated over large distances, such as tidal lakes and rivers, the tidal regime layer relies almost entirely on the station data until we can find smaller-scale ocean models to supplement the ones we are currently using.

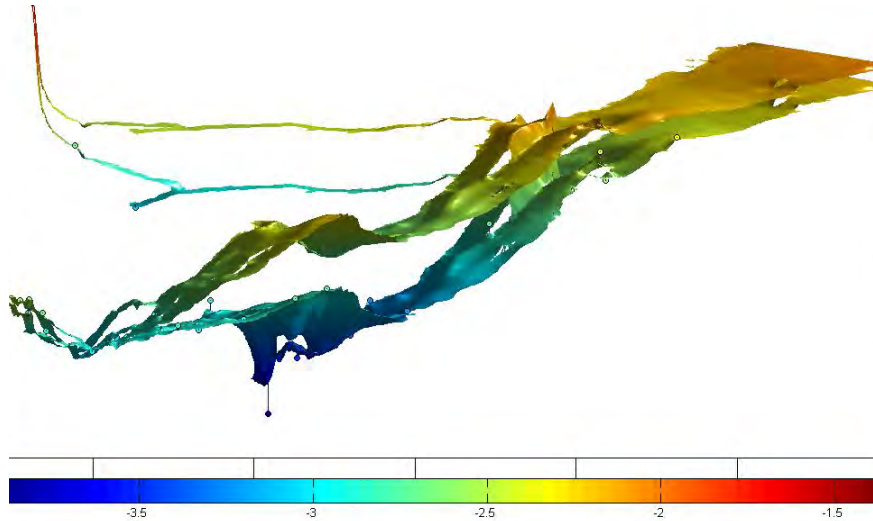

**Figure 6.** MWL to LLWLT (approximately half the tidal range) for the St. Lawrence Estuary. The top layer represents the tidal regime as modeled by Saucier & Chassé (2010) and interpolated to the STLE working grid; the circles are the same value as observed at tide gauges. The gauges indicate that the ocean model has underestimated observed tidal range considerably in some areas. The lower surface is the tidal regime on the STLE working grid after the ocean model has been modulated to fit regional trends in tide gauge observations (see text).

In Figure 6 we use the STLE model to illustrate the procedure because it is small and easy to visualize; all models display observation mismatches of similar magnitudes in amplitude and spatial extent. Figure 6 also highlights the importance of incorporating ocean models in our SEPs; they not only provide important information between gauges and offshore, but also allow us to smooth out station noise using data from physical oceanography.

#### **iv. Warp (the Difference Layer)**

Adding the previous layers gives us our best continuous model for LLWLT mapped in the NAD83(CSRS) reference frame,  $SEP_{LLWLT}$ . For hydrographic purposes we require a SEP which is coincident with CD as it has been used for the reduction of bathymetry data on existing charts and for tide tables. The offset between CD and LLWLT ( $CD_{LLWLT}$ ) at stations is on average less than  $\pm 25$  cm, but can be as large as a meter. In addition, there is a misfit between LLWLT observed at tide stations and  $SEP_{LLWLT}$ , stemming from a combination of model limitations and station noise. Thus we also require  $SEP_{CD}$ , a warped version of  $SEP_{LLWLT}$  which explicitly fits both of these differences ( $CD_{LLWLT}$  and the model misfit) in the vicinity of stations. We transition  $SEP_{CD}$  back to  $SEP_{LLWLT}$  as we move away from each station as described below.

The warp is achieved through a last layer, the difference layer, which is constrained by the difference between  $SEP_{LLWLT}$  and NAD83\_CD at stations which have been surveyed by GNSS or by geodetic levelling, and by the  $CD_{LLWLT}$  at stations without a geodetic link (Figure 7). We apply these differences in two ways: first, along a control shoreline composed of points selected from the working grid boundary; and second, at the stations nodes, which may or may not fall on the control shoreline. At station nodes and the control shoreline points closest to station nodes, the full difference is held fixed. Along the control shoreline, the difference is linearly reduced to zero

50 km away from each station except where another station is within 100 km. This creates a set of fixed values or ‘warps’ which we

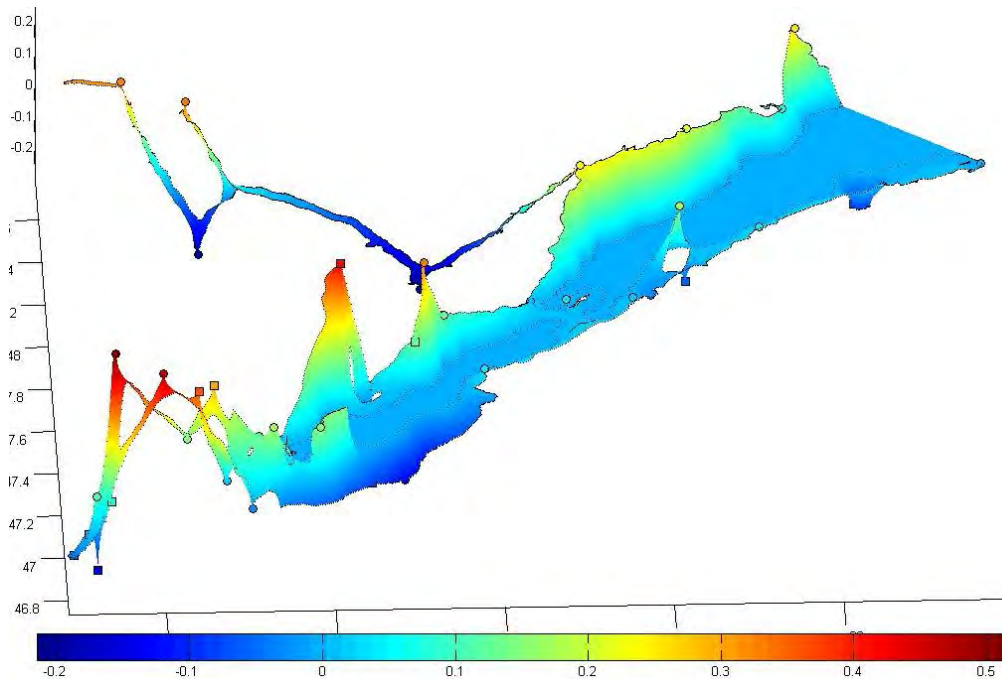

**Figure 7. Difference layer for the STLE working grid. The difference layer warps  $SEP_{LLWLT}$  to CD as described in the text. Circles represent stations with GNSS or leveling, squares are stations where only the CD to LLWLT offset is known. For this grid, the blend zone, outlined with a dotted line, is a ribbon representing approximately a 5 km buffer along the model boundary; however, the blend zone has been hand edited by the regional tidal officer because this model domain contains many shallow areas and is heavily navigated.**

interpolate across a blend zone (BZ), a ribbon of varying width buffering each working grid boundary (Figure 7). The offshore boundary of the blend zone fixed at 0. When stacked with the other layers, the difference layer will force  $SEP_{LLWLT}$  to honour CD at and around stations and along the shore between stations, gradually allowing  $SEP_{CD}$  to return to  $SEP_{LLWLT}$  in deeper waters.

#### 4. Sum & Products

The final surface after summing all the layers connects CD to NAD83(CSRS), shown in Figure 8. It is made available as a xyz file on an irregular grid. Metadata for each version of each grid is recorded in a separate file.

## Conclusion

The process described here has been used to create a set of prototype SEPs for CD and seven other tidal water datums as listed in Appendix A. A priority of the CVDCW method development has been to develop flexible tools which can be adjusted to allow for regional differences in hydrographic practices and navigation, tide station distribution, and coastal geometry and bathymetry. In practice, regional differences are accommodated primarily in the creation of the working grid, the blend zone and control shoreline, and the selection of tide station observations. Another priority has been to make the process efficient and easily reproducible, so we can



incorporate new observations and model data as they become available, as well as easily make changes to our methods. As our SEP Toolbox is primarily built in Matlab, a commonly used numerical computing environment, our methods are transferable to any group with access to the required input data for their region.

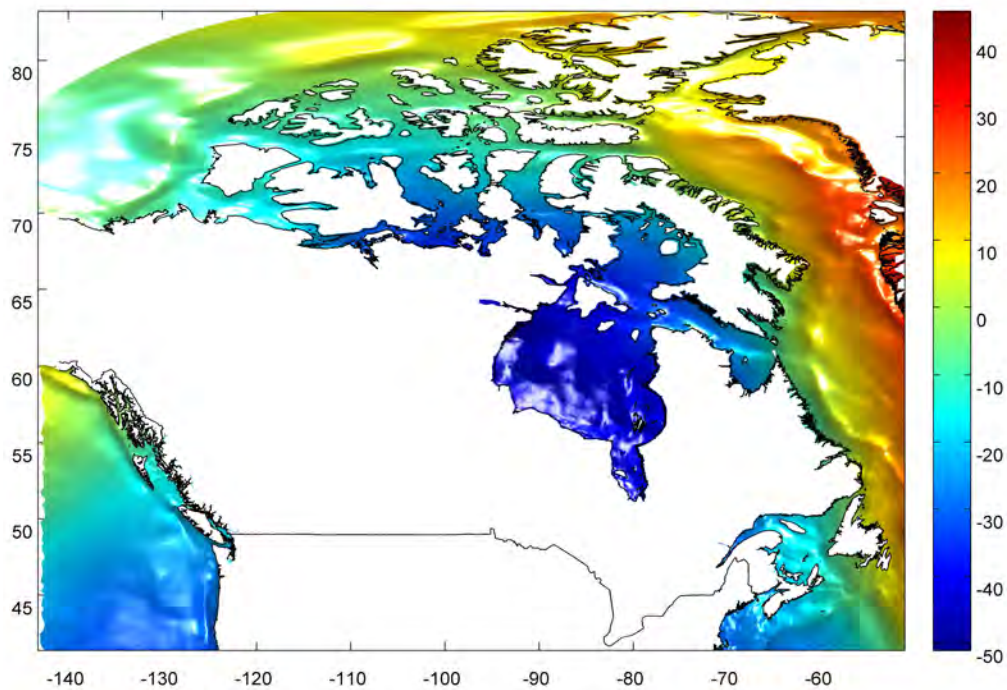

**Figure 8.  $SEP_{CD}$  for all Canadian Tidal Waters, given as a height in meters from the GRS80 ellipsoid in the NAD83(CSRS) reference frame.**

$SEP_{CD}$  will be validated in the summer 2014 field season in every region, and may be used to reduce hydrographic soundings where existing methods are known to be poor. New and upgraded GNSS and water level data continue to be acquired. In addition we are developing important changes to our methods, as well as an error grid. Thus the next iteration of the CVDCW should be a considerable improvement; indeed, the CVDCW will continue to evolve for the foreseeable future, and particularly in the next few years. Finally, the CVDCW will be a dynamic product as water levels are not static, and as such will need to be monitored and maintained as long as it is operational.

## Appendix 1: Tidal Datums

The following datums are available products for the CVDCW. All are calculated from 19 years of predicted tides.

- **Chart Datum (CD)** – a vertical datum reference established at tide gauges and used as the zero height for nautical charts and tide tables. In Canada CD targets LLWLT, a level so low that water will seldom fall below it.
- **Higher High Water Large Tide (HHWLT)** – the average of the yearly highest highs predicted over a 19-year astronomical cycle (average of 19 values).



- **Mean Higher High Water (MHHW)** – in some areas there are 2 high waters and 2 low waters per day (semi-diurnal tides). MHHW is the average of the higher of the two daily predicted high waters averaged over a 19-year astronomical cycle (average of approximately  $365 \times 19$  values).
- **Mean High Water (MHW)** – the mean of the predicted daily highs averaged over a 19-year astronomical cycle; this includes the mean of both high waters in areas with semi-diurnal tides (average of approximately  $2 \times 365 \times 19$  values).
- **Mean Water Level (MWL)** – the mean of 19 years of predicted water levels, which may be calculated at different intervals (every 60 minutes, every 15 minutes, etc) (average of approximately  $(60/\text{interval}) \times 24 \times 365 \times 19$  values).
- **Mean Lower Low Water (MLLW)** – the low water equivalent of MHHW.
- **Mean Low Water (MLW)** – the low water equivalent of MHW.
- **Lower Low Water Large Tide (LLWLT)** – the low water equivalent of HHWLT.

## Appendix 2: Ocean models

The following ocean models were used for the tidal and DOT layers of the CVDCW model domains:

Pacific: *Tides*: RiCOM (Walters, 2006); *DOT*: NEP35 (Foreman et al., 2008)

Arctic: *Tides*: Arctic9 (Collins et al., 2011); *DOT*: CREG12 (Dupont, et al., 2014)

Hudson Bay: *Tides*: (Saucier et al., 2004); *DOT* : CREG12 (Dupont, et al., 2014)

Northwest Atlantic & Gulf of St. Lawrence: *Tides*: NWATL (Dupont et al., 2002); *DOT*: (Brickman & Drozdowski, 2012) and (Wang et al., 2013)

St. Lawrence Estuary: *Tides and DOT*: STLE400 (Saucier & Chasse, 2000)

## References

- Brickman, D., & Drozdowski, A. (2012). *Development and Validation of a Regional Shelf Model for Maritime Canada based on the NEMO\_OPA Circulation Model*. Fisheries & Oceans Canada, Bedford Institute of Oceanography. Dartmouth, Nova Scotia: Canadian Technical Report of Hydrography and Ocean Sciences 278.
- Canadian Geodetic Survey. (2014). *Geodetic Reference Systems - Tools & Applications*. Retrieved from <http://www.nrcan.gc.ca/earth-sciences/geomatics/geodetic-reference-systems/tools-applications/10925>.
- Chaffey, J., & Greenberg, D. (2003). *resolute: A Semi-Automated Finite Element Mesh Generation Routine*. Fisheries & Oceans Canada, Bedford Institute of Oceanography. Dartmouth, Nova Scotia: Canadian Technical Report of Hydrography and Ocean Sciences 225.
- Collins, A., Hannah, C. G., & Greenberg, D. (2011). *Validation of a high resolution modelling system for tides in the Canadian Arctic Archipelago*. Fisheries and Oceans Canada, Bedford Institute of Oceanography. Dartmouth, Nova Scotia: Canadian Technical Report of Hydrography and Ocean Sciences 273.

- Dupont, F., Hannah, C., Greenberg, D., Cherniawski, J., & Naimie, C. (2002). *Modelling System for Tides*. Fisheries and Oceans Canada, Bedford Institute of Oceanography. Dartmouth, Nova Scotia: Canadian Technical Report of Hydrography and Ocean Sciences 221.
- Dupont, F., Roy, F., Lemieux, J.-F., Smith, G., Lu, Y., Higginson, S., et al. (2014). *CREG12: CONCEPTS high resolution ice-ocean Arctic-Atlantic model*. Environment Canada, Fisheries & Oceans Canada & Department of National Defence.
- Foreman, M., Crawford, W., Cherniawsky, J., & Galbraith, J. (2008). Dynamic ocean topography for the northeast Pacific and its continental margins. *Journal of Geophysical Research*, 35(22).
- Iliffe, J., Ziebart, M., & Turner, J. (2007, July). The derivation of vertical datum surfaces for hydrographic applications. *The Hydrographical Journal*, 125, 3-8.
- MSS\_CNES\_CLS11. (n.d.). MSS\_CNES\_CLS11 was produced by CLS Space Oceanography Division and distributed by Aviso, with support from Cnes (<http://www.aviso.oceanobs.com/>).
- Parker, B., Milbert, D., & Gill, S. (2003). National VDatum - the implementation of a national vertical datum transformation database. *U.S. Hydrographic Conference*. Biloxi, Mississippi.
- Rhein, M., Rintoul, S., Aoki, S., Campos, E., Chambers, D., Feely, R., et al. (2013). *Observations: Ocean*. In: *Climate Change 2013: The Physical Science Basis. Contribution of Working Group I to the Fifth Assessment Report of the Intergovernmental Panel on Climate Change*. Cambridge, United Kingdom: Cambridge University Press.
- Saucier, F., & Chasse, J. (2000). Tidal circulation and buoyancy effects in the St. Lawrence Estuary. *Atmosphere-Ocean*, 38(4), 505-556.
- Saucier, F., Senneville, S., Prinsenber, S., Roy, F., Smith, G., Gachon, P., et al. (2004). Modelling the sea ice-ocean seasonal cycle in Hudson Bay, Foxe Basin and Hudson Strait, Canada. *Climate Dynamics*, 23, 303-326.
- Walters, R. A. (2006). Design considerations for a finite element coastal ocean model. *Ocean Modelling*, 15, 90-100.
- Wang, Z., Greenan, B., & Brickman. (2013). Progress on the development of a high resolution model for the North Atlantic. *Canadian Meteorological and Oceanographic Society Meeting*. Saskatoon, Saskatchewan.

## Biography for Dr. Catherine M.I. Robin, presenter.



Catherine Robin received her doctorate in Physics, Geology & Environmental Science from the University of Toronto in 2010. She currently holds an NSERC Visiting Fellowship with Natural Resources Canada and the Department of Fisheries and Oceans.